



T34 World News

2014 Edition #33

CONTENTS:

- Parts Source: Upper Dash Pad reproduction
- Parts Source: Stainless Steel Bumper Sets
- Parts Source: Rear Script Tubes
- Parts Source: Repro Metal Panels
- Resto Update: Aussie 1966 Coupe
- Coming Event: Southern California T3 Meet
- Resto Update: Early-1962 Canadian Coupe
- Resto Tip: Floorpan Replacement
- Resto Update: Cherry Red 1968 Electric Sunroof
- In-Scale: Shimazaki Tin-Plate Remote Control
- Owner's Story: Henna Red 1966 Coupe in Spain
- Literature: Canadian 1964 Road Test Report
- Owner's Story: Colorado USA 1965 Coupe
- Authenticity: 6 Volt Fog Light & Horn Relays
- Owner's Story: 1966 Rumpelstiltskin
- Resto Tip: Electric Sunroof Motor Mounts
- Owner's Story: Wisconsin USA 1965 Project

Summertime is for Driving T34s

Front image is a Karmann press photograph taken of a 1967 Coupe. Rear image is of Sea Blue 1965 Electric Sunroof at a show in San Diego California USA with a seductive driver.

In late-July I handed-off more master parts for reproduction. First priority will be the LHD early lower dash pad, then the RHD one, then the early door & quarter pads. I don't have a timeframe yet but I anticipate holding a prototype in the next couple weeks which will allow me to take pre-orders. I will send a notice via Facebook & the T34 email list for pre-orders. There's no idea on the costs yet until I hear back from the manufacturer. The good news is that very soon T34 owners around the world will have an answer for cracked & missing pads. Never before have we had these answers, so I'm happy that the quality of these reproductions is good enough & the prices are reasonable as well.

I was fortunate to find a RHD glovebox liner courtesy of **Michael Gilbert** in England in July. He's restoring a 1965 LHD and only had a RHD glovebox. I needed the RHD version as a master to create the reproduction in fiberglass and soon we'll have both the LHD & RHD liners available.



In 2011 the California T34 owners met along the Central California coast with 20+ other T3 owners (below) to celebrate the 50th Anniversary of the T3. This October the **Cayucos T3 Rally** event is happening again in the same location. This time it's being organized more like a rally (staged departures, timed sections, & no stopping for photo ops). So far it appears that there are 30+ T3 owners coming and I know at least 5-6 of those will be T34 drivers. I'll be there enjoying the two days of 100+ mile driving along the scenic California coastline & wine regions. Hope to see you there too. More info inside & photos below.





T34 World International Team

The key to the success of T34 World will be maintaining an active group and the support of T34 owners in many different countries speaking many different languages. Our team of 34 dedicated T34 reps in 21 countries will help T34 owners in their regions, reporting back on events in their areas, and maintaining contacts with parts sources. Here's your international team! Please contact them directly.

ADMINISTRATOR: Lee Hedges (LeeHedges@T34World.org)

GERMANY:

- Cabriolets – Jörg Fischer (JorgFischer@T34World.org)
- Western – Carsten Klein (CarstenKlein@T34World.org)
- Southern – Michael Mosinger (MichaelMosinger@T34World.org)
- NorthEast – Matthias Andree (MatthiasAndree@T34World.org)
- NorthWest – Klaus Morsch (KlausMorsch@T34World.org)

UNITED STATES:

- Southern Calif – Bob Walton (BobWalton@T34World.org)
- Central Calif – Tom Reay (TomReay@T34World.org)
- Northern Calif – Larry Edson (LarryEdson@T34World.org)
- Mountain States – Paul Colbert (PaulColbert@T34World.org)
- Mid-West USA – Greg Skinner (GregSkinner@T34World.org)
- NorthWest USA – Jason Weigel (JasonWeigel@T34World.org)
- Central USA – Bob Dervin (BobDervin@T34World.org)
- NorthEast USA – Rick Hasse (RickHasse@T34World.org)
- SouthEast USA – Allyn de Vars (AllynDeVars@T34World.org)

AUSTRALIA:

- Walter Glaser (WalterGlaser@T34World.org)

BELGIUM:

- Jurgen Magdelyns (JurgenMagdelyns@T34World.org)
- Paul Peeters (PaulPeeters@T34World.org)
- Jimmy Vernelen (JimmyVernelen@T34World.org)
- Mike Zanella – Liège (MikeZanella@T34World.org)

UK: Mark Poulton (MarkPoulton@T34World.org)

BRAZIL: Fernando Mendonca (FernandoMendonca@T34World.org)

CANADA: Ron Buckley (RonBuckley@T34World.org)

DENMARK: Morten Christensen (MortenChristensen@T34World.org)

FINLAND: Timo Tanhuanpää (TimoTanhuanpaa@T34World.org)

FRANCE: Franck Boutier (FranckBoutier@T34World.org)

INDONESIA: Iwan Sadono (IwanSadono@T34World.org)

ITALY: Antonio Pellegrino (AntonioPellegrino@T34World.org)

JAPAN: Toru Ebine (ToruEbine@T34World.org)

MEXICO: Antonio Martinez (AntonioMartinez@T34World.org)

NETHERLANDS: Remco de Bruijn (RemcodeBruijn@T34World.org)

NEW ZEALAND: John Kanters (JohnKanters@T34World.org)

NORWAY: Dag Henriksen (DagHenriksen@T34World.org)

PHILIPPINES: Dindo Razonable (DindoRazonable@T34World.org)

SOUTH AFRICA: Greg Davids (GregDavids@T34World.org)

SWITZERLAND: Philip Egger (PhilipEgger@T34World.org)

THAILAND: Nam Xanasongkram (NamXanasongkram@T34World.org)



Parts Source: Repro Upper Dash Pad

One of the most common parts needed for the vast majority of T34s in the upper dash pad. The large front window lets in a lot of light and the cockpit generates a lot of heat, so the upper dash pad tends to get cracks. Another big problem is when old window seals allow water to drain down the corners and onto the dash corners, creating rust on the dash pad bolts. This causes them to be impossible to remove and the bolt breaks away from the dash pad's foam hold.

Lee found a reputable fiberglass specialist in San Diego that creates dash pads for other rare VW models. He convinced the guy to make the T34 upper dash pad. An uncracked original pad was used for the master and a mold was made preserving the pebble-grain texture & shape of the curved upper dash pad. It took two months for the reproduction process to create the prototype. The four bolts were fitted in exactly the right positions for easy installation. The great thing about fiberglass is it won't ever crack, warp, or get damaged over time. This reproduction will fit all years & models of T34 from 1962-69.

Contact LeeHedges@T34World.org to order. Orders within North America costs US\$348 & International orders are US\$369, which includes packing, shipping, insurance, & tracking. PayPal accepted to LeeHedges@T34World.org

NOTE: Unfortunately, Australia, Brazil, & Thailand have restrictions for the maximum length a box can be (42") and the dash pad box is 55", so I'm unable to send to these three countries. UPS & FedEx costs are US\$300+.





Parts Source: Stainless Steel Bumper Sets

With the costs of rechroming T34 bumper parts increasing every year and now you can expect to pay US\$1000 to rechrome the bumpers, we're fortunate to have new reproduction bumpers! Thanks to the **KGOC-GB club** in UK led by **Andy Holmes & Mark Poulton**, both the front & rear bumper sets are available. They're made of stainless steel so they look bright & shiny without the hassle of chrome plated parts getting rusty over time.

The KG Owner's Club Great Britain is a fee-based membership club in the UK that has been supporting KG owners (both T14 & T34) for several decades. Members have benefits of buying parts directly from the club's inventory at reduced prices. You can join the KGOC-GB at <http://www.kgoc.org.uk>

These reproduction bumper sets were based on original pieces and they've been tested for fit & finish by Andy Holmes, an expert in our marque. There will be both the early "pointed" style & late "rounded" style bumper guards produced.

Andy Holmes received the final production set in early-August and needs to test-fit them for quality. Cost for both the front & rear sets have not yet been finalized, but it's planned to be approximately US\$1350/£799/994 Euro which includes postage and all import costs. The Vietnamese supplier will be accepting orders in August. We'll share the ordering info once it's known.





Parts Source: Rear Script Tubes

When the time has come to replace the tiny nylon tubes for mounting the scripts on the rear panel, you'll find these parts very difficult to find. **John Kanters** from New Zealand was recently in this situation and discovered a New Zealand source to complete his 1963 Coupe resto.

<http://www.rarespares.net.au/rsnz/productpage.aspx?product=NS0024>

These gray nylon tubes are 2mm inner diameter to grab the pins on the back of the scripts, 3mm outer diameter to slide into the holes in the rear panel without modification, & 7mm long.

Rare Spares New Zealand part #NS0024 and the cost is US\$10 for six tubes. Depending on the year of your T34 you could need eight (S models) tubes.





Parts Source: Reproduction Metal Panels

Jurgen Magdelyns in Belgium has reproduced several T34 metal panels for many different areas that are commonly rusted-out. Please contact him at JurgenMagdelyns@T34World.org for shipping costs to your location. He accepts PayPal for payments.

- Lower rear corners 190 Euro
- Wheel arches 190 Euro
- Rocker panels 550 Euro (six pieces)
- Lower rear apron 130 Euro
- Spare tire well surrounds





Resto Update: Aussie RHD 1966

Walter Glaser from Sydney Australia bought a complete restored 1966 RHD Coupe #346 O36 321 a year ago but now has made the tough decision to completely disassemble it to do a top-quality restoration.

Walter sent off for the birth certificate from the VW Archives and when it arrived he learned the T34 was originally Arcona White. It's one of the early-1966's that were painted Arcona White (while later production 1966's were painted Lotus White). It was built on 20 September 1965 & delivered to Melbourne Australia. He was really hoping to see an M-Code for the special 1966-only Pigalle interior, but the certificate only said "red upholstery material".

When the mechanic pulled most of the car apart he saw the pads & trims had been previously recovered in red vinyl and were originally black, killing his dream of owning a Pigalle T34.

Below: At first glance you might think this 1966 was a Pigalle since the dash pads, dash grab handle, & steering column are red. But after a closer examination of these parts he discovered they were painted red or covered with red vinyl by a previous owner.





The body had been covered with a ton of bondo so when the shop stripped a lot of paint off unfortunately they discovered the body had been involved in a major accident on the left-front & right-rear sides. The previous repairs were poor leaving the T34 slightly bent. Walter plans to have the shop replace the rear apron, front nose, and likely the right-rear quarter panel. Walter was very disappointing.

In addition to the body panels, he plans to replace the rocker panels to attain the sharp "ghost lines" that run above the rocker panels. The floorpan had patches previously welded in places which looked shoddy so he'll replace both floorpan sections. Walter chose a vintage car restorer who does file finishing and lead wiping, signs of top quality old-school craftsmanship. Unfortunately he's so in-demand that the repairs won't begin until the beginning of 2015. Considering he's got some serious panels to locate, he'll need the six months to find them!



Event: Central California T3 Rally in Cayucos

On 03-05 October 2014 T34 owners will meet in Cayucos along the central California coastline for a fun weekend of driving T3s! This event is open to all T3 owners. In 2011 there were 20+ T3s enjoying the cruising, friendships, dinners, & great conversations. Book your hotel rooms now because rooms are being reserved quickly.

Thursday 02 Oct – Arrival in Cayucos & 7pm Dinner

Friday 03 Oct – Rally driving events 100+ miles

Saturday 04 Oct – Rally driving events 100+ miles

Sunday 05 Oct – Morning get together then drivers leave for home

There will be cruises to Cayucos leaving from San Diego, Los Angeles, and other regions. For the latest info please check out the Samba T3 forum called 2014 T3 Rally

<http://www.thesamba.com/vw/forum/viewtopic.php?t=571113>





Resto Update: Early-1962 Canadian Coupe

Ron Buckley is our Eastern Canada rep for over 20 years now. He lives in Nova Scotia, Canada and has been restoring his early-1962 #O 027 895 that was built on 31 March 1962. It's the second oldest T34 in Canada.

Previous to his ownership Ron believes someone must have backed out of the garage and put a good crease all along the door. He has taken most of the crease out from the driver's door and with a thin skim of body filler it's almost to his liking.

Ron's original headlight bowls did not survive the 50 years of salted roads & harsh winter climates in eastern Canada, so he made new ones. He started out with pie-shaped pieces of steel then welded them together and hammered them out to shape the bowl. He ground-off the welds to get a smooth surface. These pictures are the intermediate step of welding and hammering.





Old-school metal craftsmanship is the only way to fix the spare tire well.

Ron recalled seeing an image of an original window winder pin removal tool. He knew he's need one when he got to the interior so he decided to make one for himself. It's a simple yet useful tool!

He's currently welding in replacement floor panels that he bought from ISP West in California that was featured in this news magazine. One side is completed already and the other ready to weld.

Most Canadian VWs were fitted with gasoline heaters that blew warm air into the cabin (in addition to the standard heat from the heater boxes that only blew warm air when you were moving). The Perfection model PC 1500 gas heater in his 1962 T34 was mounted in the right side of the front compartment. Three large holes were cut in the spare tire well with tubes carrying the fresh-air inside the car to the gas heater. Since Ron was scared of these gas heaters, he's chosen not to install it in the T34, so the holes in the spare tire well needed to be repaired. He welded-up the three large holes and finished them before repainting the spare tire well.





Resto Tip: Floorpan Replacement

Water collects in the floors of T34s, like all vintage VWs, and then rust eats away at the steel until it begins to disintegrate. The most common areas for rust in the floorpans are in the rear footwell, battery area, and the front corners. In some cases you can stop the rust & use POR-15 to harden the original metal, but in some cases you'll need to cut-out the rusty sections and replace them with new metal panels.

Gerson (Bogotá Columbia) is the only source for full-length steel stamped T3 floorpan sections. Your local vintage VW shop can usually source these for you by ordering from Gerson. Cost for the panels is about US\$500-600/pair + shipping.

Michael Moesinger (Germany) recently completed the restoration of his Lotus White 1966 Electric Sunroof and thankfully he fully documented the steps he took to replace the full-length floorpan sections with the Gerson panels. These photos are of his work.

Upper Right: The first step is to take accurate measurements of the existing seat rails because they are unique to T34s and are not included with the Gerson panels. Also, take measurements of the round metal pad dots used to secure the floor mats in-place.

Lower Right: Carefully cut-out the rusty floorpan sections from the existing pan being sure to leave enough metal to weld the Gerson panels back in.





Above: To facilitate the alignment of the body mounting holes with the floorpan holes, Michael had the body mated onto the chassis again.

Below: When aligned, the new Gerson panels were welded into place.



Below: The next step is to carefully place the seats into the seat rails and weld the rails onto the Gerson pans using your previous measurements. With sunroof T34s, some owners have cut the seat rail height down to allow more headroom for taller drivers.





With the welding done you can then primer & paint the entire chassis.



Resto Update: Cherry Red 1968 Automatic Sunroof

Tom & Terri Reay from Central California USA have been reassembling their 1968 with the plan to finish it in-time for the Cayucos T3 Meet in early-October. This past month they focused on the headliner & compartment liners.

Headliners for Electric Sunroof models are different because they do not use the metal rods like Coupes have to keep the headliner tight into the roof panel. The headliner gets glued to the metal box frame of the sunroof. A long zipper gets sewn into the rear edge, allowing access to the sunroof motor, shaft, & clutch components. Once the roof section is glued & clamped into place then the pillar material gets installed.

Tom & Terri said their 2003 experience with creating the headliner for their Sea Blue 1965 Electric Sunroof really helped them 11 years later when doing the 1968's headliner. They had the upholstery shop sew the zipper and John Kanter's advice on installing it helped a lot.

The liner material from SMS in Oregon is a perfect match.



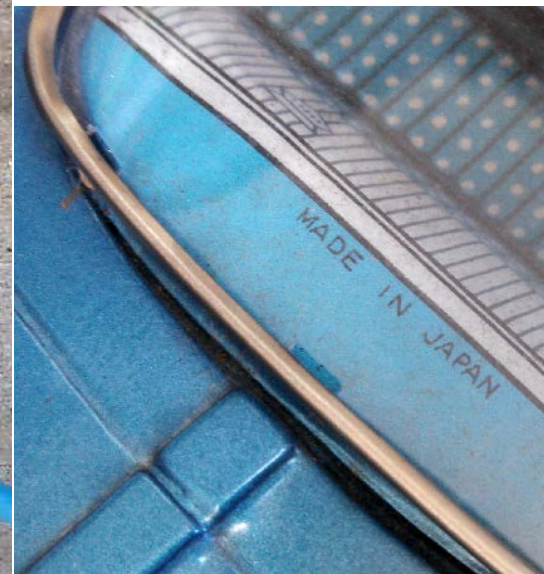

In-Scale: Shimazaki Tin Plate Remote Control

1960's Japanese tin plate, 22 cm length by 9.5 cm width by 6.6 cm height.

Japanese tin plate scale models were popular for children. Most every car model was produced including Beetles, Buses, T14s, and in 1961 the VW 1500 series as well. The two tin plate manufacturers that offered T34 models were Ichiko & Shimazaki. Based on the tin plate technology, these were likely first produced in 1965, but there's no historical documentation to prove the first production year.

This model is a battery-operated tin lithographed remote controlled T34 Coupe with the original paper box made by Shimazaki in Japan. The wheels and hubcaps are all separate tin pieces with highly lithographed interior and dashboard. The headlights have tiny bulbs that light-up (but the key wind-up version doesn't).





The tin red remote control has a plastic yellow wheel (matches the driver's wheel inside) that controls the front wheel direction and there are two red push-buttons to select forward & backward.

There are three yellow plastic parts (steering wheel, front signals, & tail lights). The windshields (front & rear) are clear plastic and both have polished tin trim. There's a rear license plate with the KG script which is also on the glovebox door. The hub caps have VW logos. And the paper box has VOLKSWAGEN Karmann Ghia.

This version with remote control unit does not have any identifications on the chassis, but the later key wind-up version has the KG script embossed with Made in Japan.

The paper box is large for this version to hold the remote control unit, but the key wind-up versions had a smaller box using the orange & green T34 graphics.

These days the large tin T34 models are going for extreme prices but realistically they're probably worth from US\$400-500 with their original paper box.





These large tin plate models were originally offered in toy stores, candy shops, and souvenir shops. This remote control version was considered the highest luxury model. As the 1970's arrived tin plate models were so numerous that they began to be produced with lower quality features (no lights, no remote control, and poor tin stampings).

Below: Three of the less-expensive versions. Blue friction key wind-up model. At the end of production there were remote-control models made with a simple green wire & without a steering wheel on the controller like this red one. And a green version with white steering wheel & no key nor remote controller.





Owner's Story: Henna Red 1966 Coupe in Spain

Rubén Fidalgo lives in La Coruña Spain and enjoys driving & maintaining his Henna Red & Black 1966 T34 Coupe, just like his father taught him as a boy. When he turned 8 years old his father taught him how to drive. The first lesson was on an ISO motorcycle, then a VW 411 Automatic, and finally at 9 years old, he dared to teach him to drive a car with gears so Reuben learned to drive his father's prized dark blue 1967 VW Variant.

In June 2006 Rubén heard from a friend that a T34 was for sale in France for 7200 Euros, a two-owner 67K km Lotus White with Black roof 1966 T34 Coupe. That year he was watching the World Cup 2006 and Spain had just been eliminated in the second round. The French were playing the Brazilians in the next game as he was contemplating buying this T34, so he couldn't sleep. He named the car Cyrano (because it was found in Bergerac France). He saw that it had all of its original parts, all its chrome parts, and that under the appearance of neglect it had a good foundation.

So Rubén decided it was worth buying this rare VW and came to an agreement with the seller for 5500 Euro. He borrowed his friend's car & trailer and drove to France to bring his new 1966 T34 home. Once he got home he was unable to sleep, not because France had defeated Brazil to advance, but because he was thinking about how to restore this T34.

This was the first view of the T34 in France ... complete & driving but in need of a makeover.



His original plan was to restore the T34 to sell and make a profit. He didn't like the white color and decided to repaint it red, because it's easier to sell a beautiful red T34. He chose Henna Red L553 from 1966.

The body was stripped, doors & hoods removed, and the various dents were repaired. Two months later in September the T34 had been painted, the clutch repaired, and the seat upholstery restored. It was time to take the T34 to the car show in nearby Exponor, and the show was great but no one was interested in buying the T34.



By December Rubén changed his mind and decided to keep the T34. He wrote to VW to get the birth certificate and discovered Cyrano was born on 24 December 1965. Part of what made him keep it was that the T34 was not a new feeling for him, as his father's 1967 Variant had the same driving experience.



Above: In April 2007 he was asked to do a comparison between his T34 and a friend's Saab Sonnet for the Classic Cars magazine. He drove to Madrid & back without a single problem. He loves the 1966 model features with its painted dash, refined dash knobs, and front disk brakes.



Ruben is thankful to his friend Cresslime for allowing him to retrieve the T34 in France, thankful to Viv for going with him, and of course, thankful to his father for teaching him the value of restoring something with his own hands is more meaningful than if that thing is simply bought. This 1966 T34 is now part of him and he loves the feeling it gives him while driving in Spain. These scenes make us all want to visit España!



The beautiful port city of Caniño, in Vigo, Pontevedra



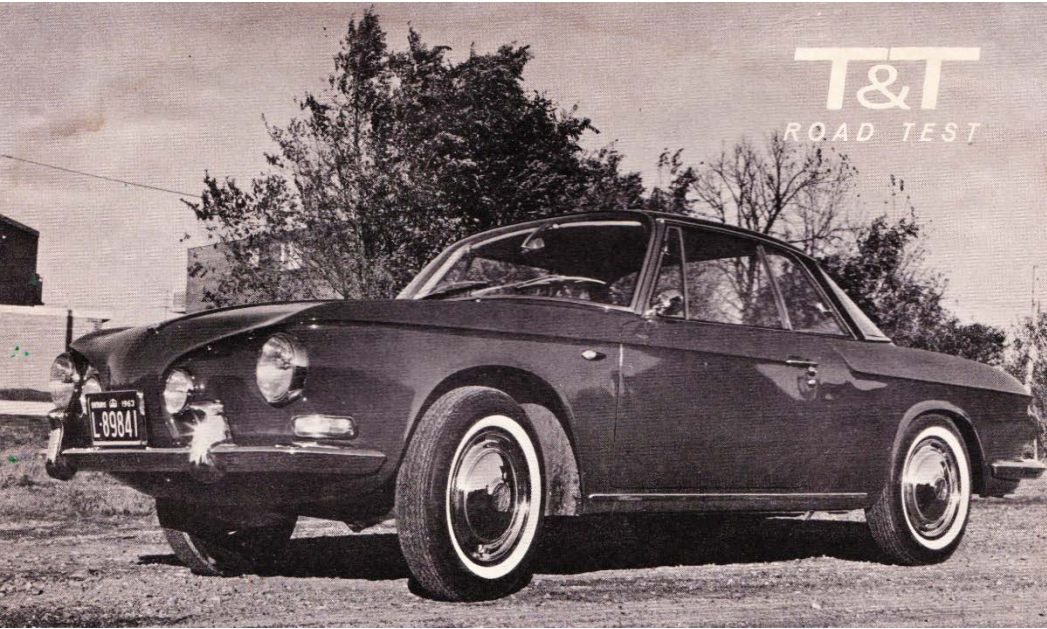

Literature: Canadian 1964 Road Test Report

Track & Traffic magazine featured the 1964 model T34 Coupe in their December 1963 edition. This was one of Canada's popular automotive magazines that brought new innovations & models to the public eye.

INITIAL IMPRESSION: A 1500cc, two-carb, 66hp air-cooled engine with all-synchro four-speed gearbox & fully-independent suspension, reclining bucket seats, & a sleek Coupe body styled by Ghia are specifications that describe a sports car. Without dampening the spirit of Porsche owners, we'd like to classify it as a much lower priced version.

COACHWORK: There's a feeling that Ghia must have been under some American influence when the 1500 was designed. It's a very striking looking machine, more elegant than racy, it comes off in our books as a handsome piece of design. In creating the basic shape Ghia figured on vision, headroom, and trunk space as important items, forming the outline around the essentials, then using sculptured forms to stylize.

INTERIOR: There's no sensation of being crowded in the 1500 Ghia. With both seats being adjustable the driver has no trouble achieving his ideal position. Seat back contour is extremely comfortable. The rear jump seat is quite acceptable for two kiddies and when folded down it becomes a flat platform for luggage. Padded armrests are built into the doors, and padded dash & sun visors are a luxury touch. The interior is well designed with an emphasis on comfort.

INSTRUMENTS: All dials are round, easily read, and an electric clock is included, however, in view of the Ghia's new power the clock should make way for a tach. The position of pedals, gearshift, and steering wheel is ideal. Light & wiper controls are grouped into a panel on the left, twin fresh-air levers in the center of the dash, and a quick heater delivers hot air from the dual controls between the seats.

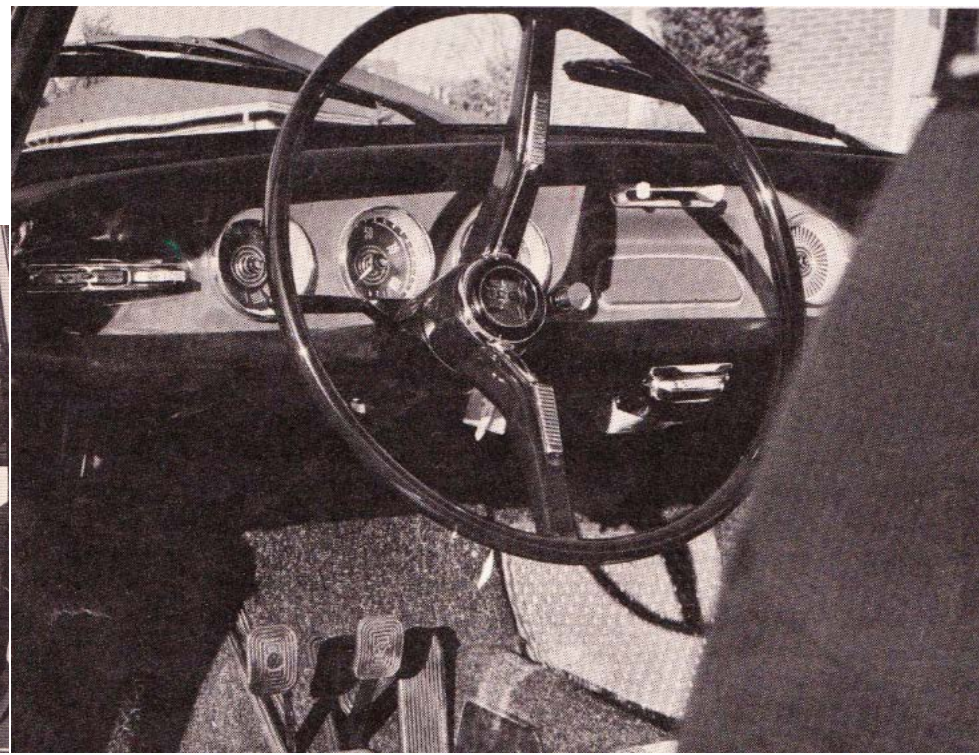
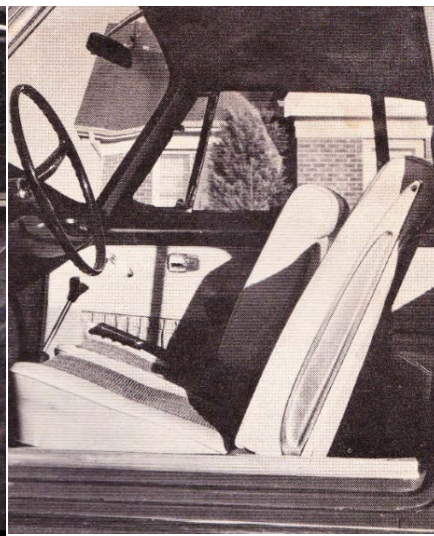

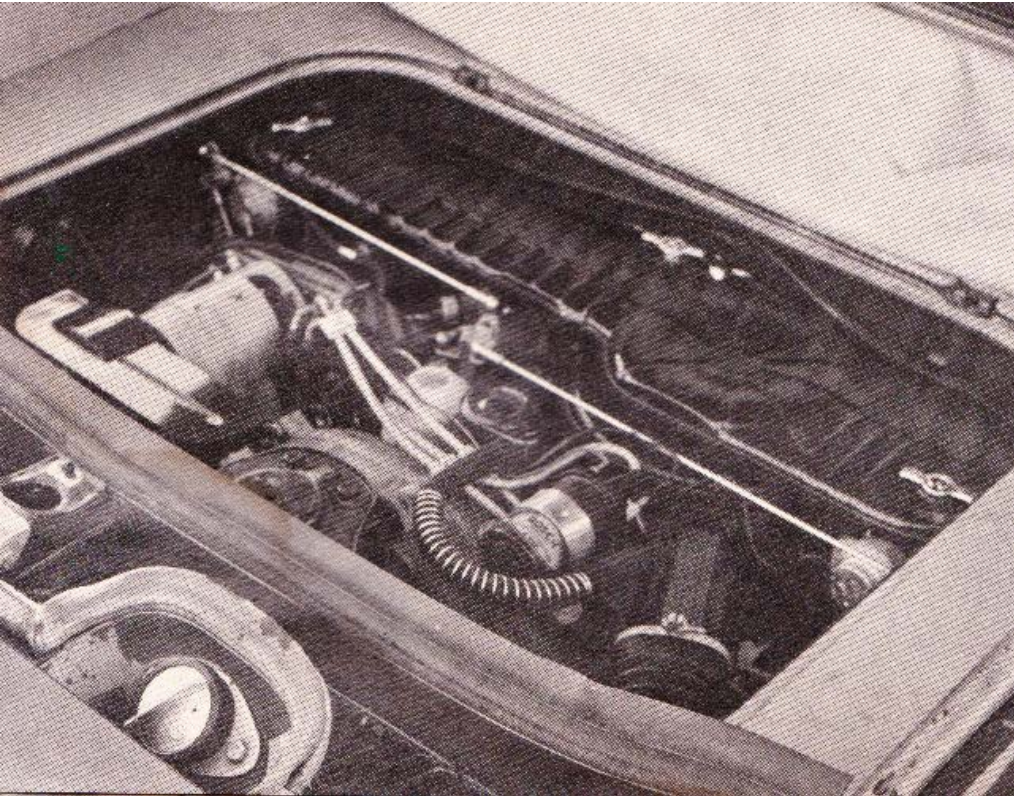

ENGINE: Power in the 1500 Ghia is an air-cooled four with fan mounted flat over the cylinders for an overall height of only 17 inches. Twin carbs and slight cam mods provide more horsepower, more torque, and higher revs. The sound is compatible with sports car traditions. The gearbox is all-synchro, crunch-free, and very quick. The stubby gearshift lever sits where it should and moves without effort.

TRUNKS: There are no less than three luggage areas in the Ghia! Trunk number one up front is deep enough for a good sized case or two. Number two is case-sized behind the rear seat. And number three is over the engine, shallow but good for odds & ends.

HANDLING: You won't believe us when we say it has sports car roadholding, but it has, honest to Porsche! Oversteer was completely controllable in every circumstance, while light quick steering made handling pleasant. Body lean is negligible and cornering characteristics differ little in low or high-speed turns. The one fault is not having an optional "speed" tire, especially for wet conditions. Ride is smooth with all independent torsion bar suspension and 15" wheels.

PERFORMANCE: All our sports car terms might lead you to expect red-hot performance, but it's not THAT fast. Acceleration and top speed are now comparable to the low-priced, small-displacement sports cars. A slow-turning fourth gear delivers benefits of long wear, low gas consumption, and quieter fast cruising. The 1500 Ghia is a much faster car with more than adequate performance which includes the brakes with big drums but no disks which means fade but no frights.

SUMMARY: Forgive us if this road test has overtones of sports car impressions but that's exactly the way it affected us. Truly it has some of the Porsche attributes, and the Ghia turns out to be a beautiful Coupe with an emphasis on comfort, ideal for town or trips. The new TS engine has brought about a complete transformation of the car. Those that like sleek European Coupes because of chic styling will undoubtedly buy it purely for appearances but we strongly recommend the sports car enthusiast take a ride. It offers superior comfort, ride, and quality at a medium price.

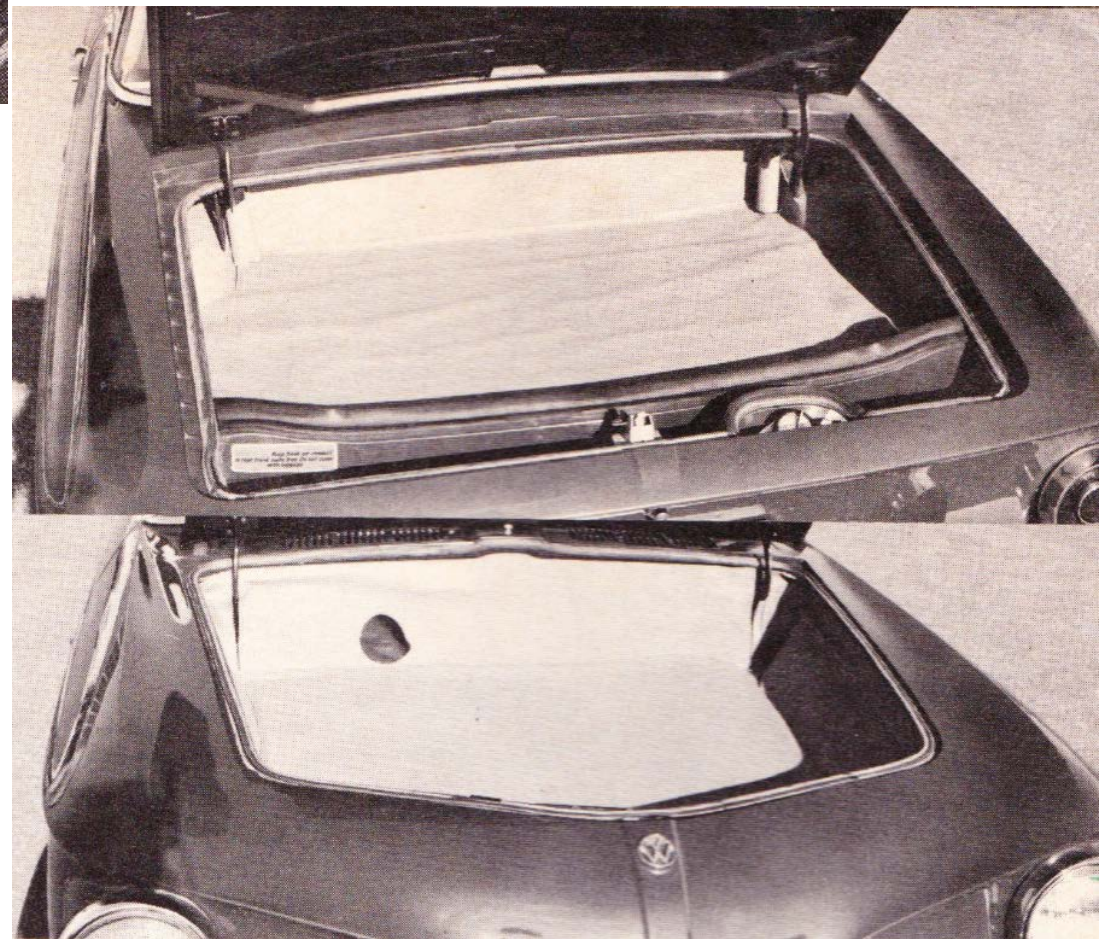

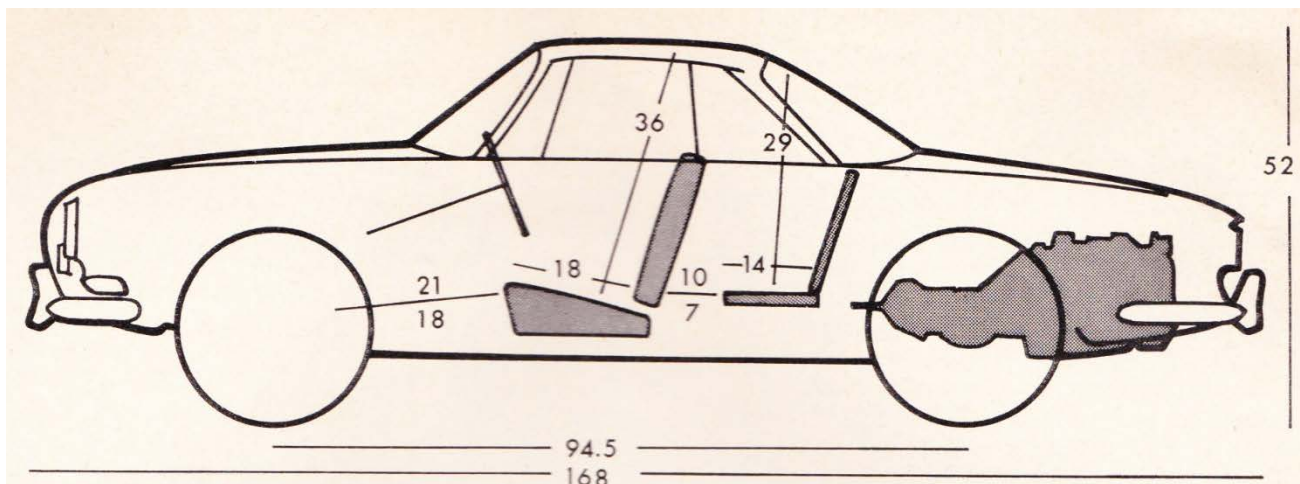

KARMANN GHIA 1500

Engine: Air-cooled flat-four, rear-mounted.
Bore: 3.27"
Stroke: 2.72"
Displacement: 1.493 cc.
Compression ratio: 8.5:1.
Maximum power: 66 bhp @ 4,800 rpm.
Maximum torque: 83 ft. lb. @ 3,000 rpm.
Brakes: drums, front and rear.
Transmission: 4 speed, all synchro.
Ratios: 1st: 3.80:1; 2nd: 2.06:1; 3rd: 1.32:1; 4th: 0.89:1.

Front suspension: independent transverse torsion bars sealed in tubes, anti-roll bar.
Rear suspension: independent transverse torsion bars sealed in tubes.
Steering: worm and roller, 2.8 turns lock to lock.
Wheelbase: 94.5"
Length: 168.4"
Width: 63.7"
Height: 52.4"
Weight: 1,984 pounds.
Fuel capacity: 8.8 gallons.

acceleration times

0-30 — 3.9 seconds
 0-40 — 7.2 seconds
 0.50 — 11.5 seconds
 0-60 — 16.8 seconds
 0-70 — 26.3 seconds
 0-80 — 33.5 seconds

SPEEDS

1st: 21; 2nd: 45; 3rd: 72; 4th: 90

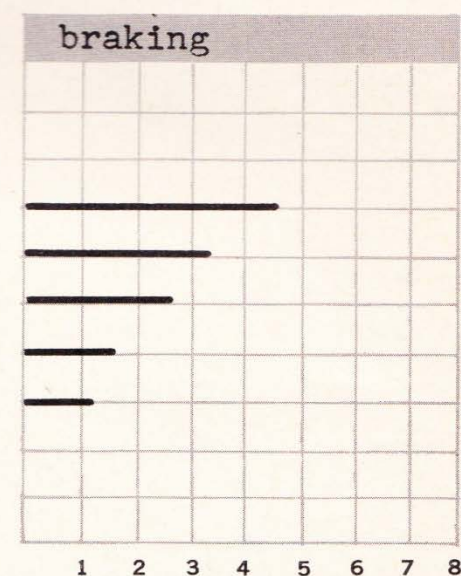
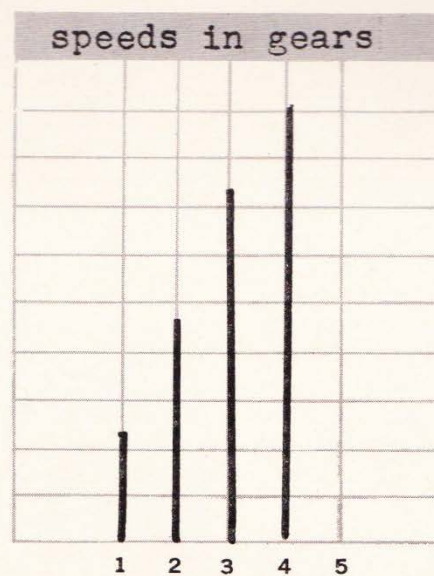
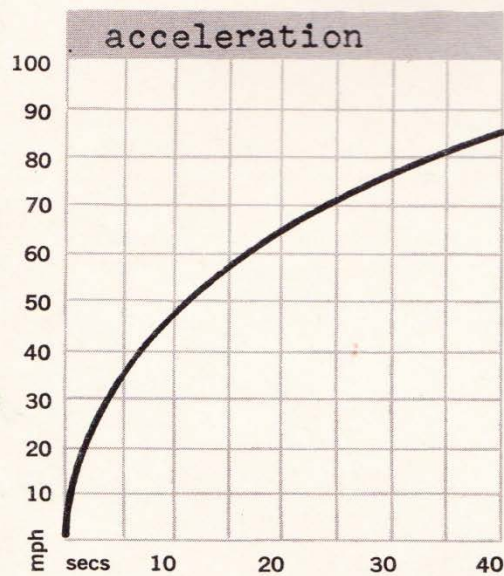

Ruby Red & Black 1964 Coupe in a German VW dealership display window





Owner's Story: Colorado 1965 Coupe

Steve Dunn lives in Littleton Colorado USA and he's been working hard on the restoration of his new 1965 Coupe #345 031 690 since January.

Owned since 1984 by John Andrew in California, he moved to Telluride, a ski resort high in the Rocky Mountains, and it was not driven until John decided to sell it in 2011. Originally Arcona White with a Black roof, the exterior had been painted solid Copper Brown when John bought it. John had sent for the birth certificate in 1999 and learned it was built 15 September 1964 and delivered to Hamburg Germany. John bought it from a German guy in California that claimed to have rescued it from a junkyard.

Lucky to have found a complete T34 with its original engine, these were photos of it coming out of Telluride in 2011. Dash pads were both cracked, seats had been redone but were in poor condition, door map pockets were missing, but the body was in relatively rust-free condition. The speedo was the original 160 km version from Germany so he found a 100mph speedo & fuel gauge that was from a 1965 being parted-out in Wisconsin.

Below: full set of 1965 gauges ready for restoration





Steve sent the gauges to Lee for restoration at Foreign Speedo in San Diego, experts in T34 gauge resto.

Interior panels & carpet kit were supplied by SewFine in Colorado and they were even able to cover the dash pads with vinyl for a clean look.

The radio Steve found installed in the T34 dash was a Blaupunkt Frankfurt TR model T-series. That means it was designed for the American market and likely sold by a VW or Porsche dealer. The T-series were made for the 1962 model year cars so it's likely that it was added some time after the T34 was bought.



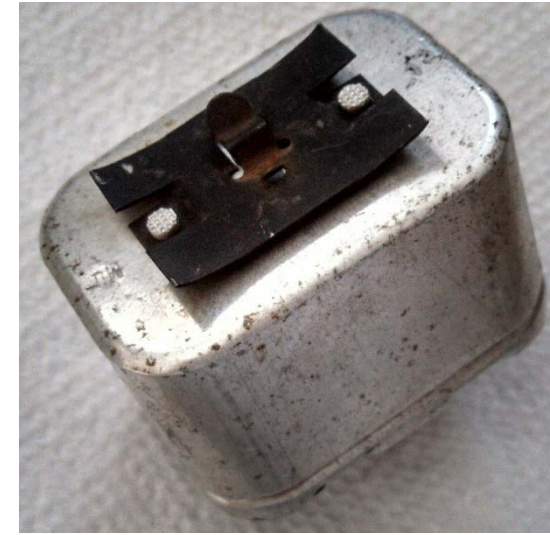
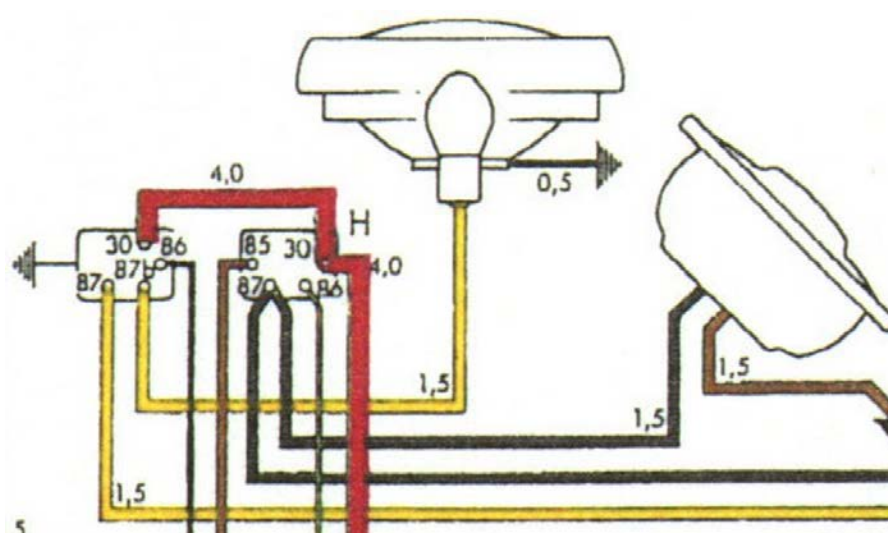

Authenticity: 6V Fog Light & Horn Relays

All T34s have special wiring relays for the fog lights & horns (above). On the early 6V T34s (1962-66) these relays are getting tough to find. And when diagnosing the fog lights & horns, it's an essential component.

The fog light relay (right) is #211 953 191, which is obviously a VW Bus part number. The four-prong relay connects the main power wire (30) with the two fog light power wires (87 & 87b) and a thin wire to the fog light switch (86).

The horn relay (below) also has four prongs and it connects the main power wire (30) with the two horn power wires (87) and the horn ring ground (85) and a thin wire to the fuse box (86). This one has no part #.

Both relays are grounded by a metal tab at the top which is clipped into a hole in a metal plate under the front hood lip (top left).

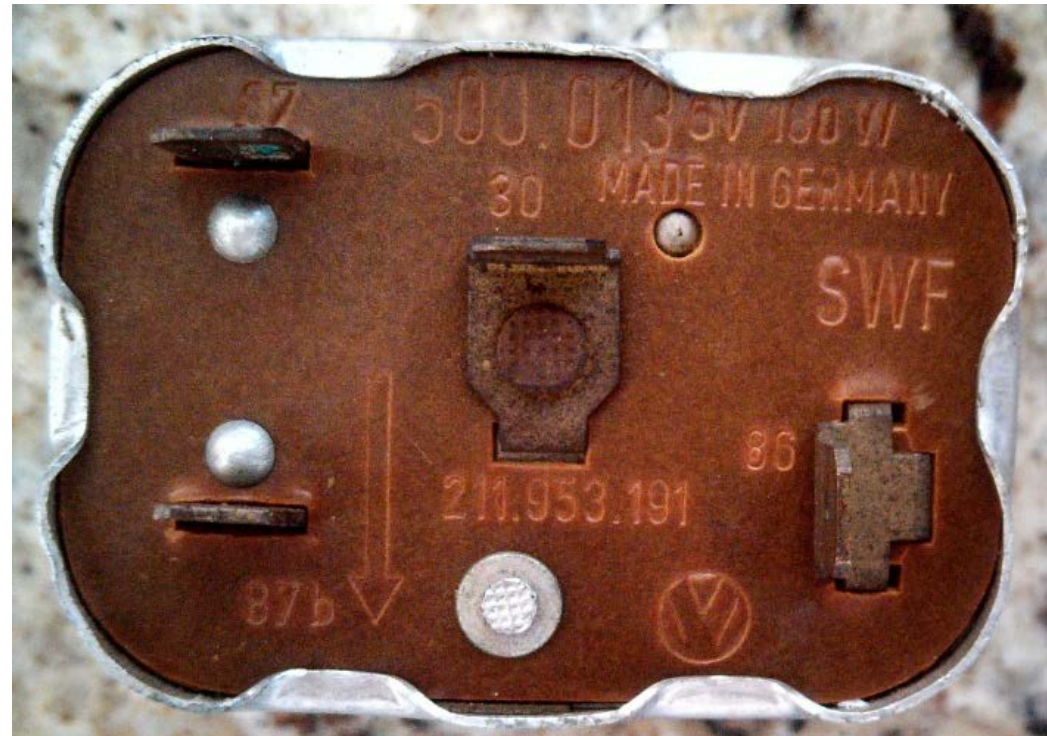

When searching for a replacement 6V horn relay, any four prong 6V horn relay will work. Often times you can find an original T14 KG one on theSamba for under US\$15 if you're patient but NOS are US\$50. Search for T14 KG with part #141 951 251B.

Finding a replacement 6V fog light relay isn't that easy. This relay was also used by Porsche and with the accessory fanfare dual horns. NOS ones are listed at US\$150.

Owner's Story: 1966 Rumpelstiltskin

Thom Balch was an active member during the early T34 Registry days in the 1990's. Back then there was a printed newsletter & Thom says he misses those times. His 1966 Coupe is finally up in the air and he's prepping it toward being back on the road for the first time since 1980. That was a 35 year nap!

Tom found it in 1996 and since then life got in the way. He says it feels good to be working on it again! He found a little more rust in the rear quarters than he remembered.

This is a 1966 Lotus White Coupe (chassis #346 243 944 with engine #TO 209 067), built on 25 April 1966 and delivered 02 May 1966. The original engine is rebuilt and still sitting on an engine stand. The transmission has been removed and cleaned. Thom completely replaced the brakes including a NOS 1966 disc brake master cylinder, ball joints and bearings.

The 1966 still needs at least one nice taillight base, a front fender Karmann badge, and some other goodies. He's excited to hear that the upper & lower dash pads are being reproduced! Thom says it's great to see Lee still around and accessible and wanted to say "thanks for all you did for/with the Type 34 Registry back in its glory days!"



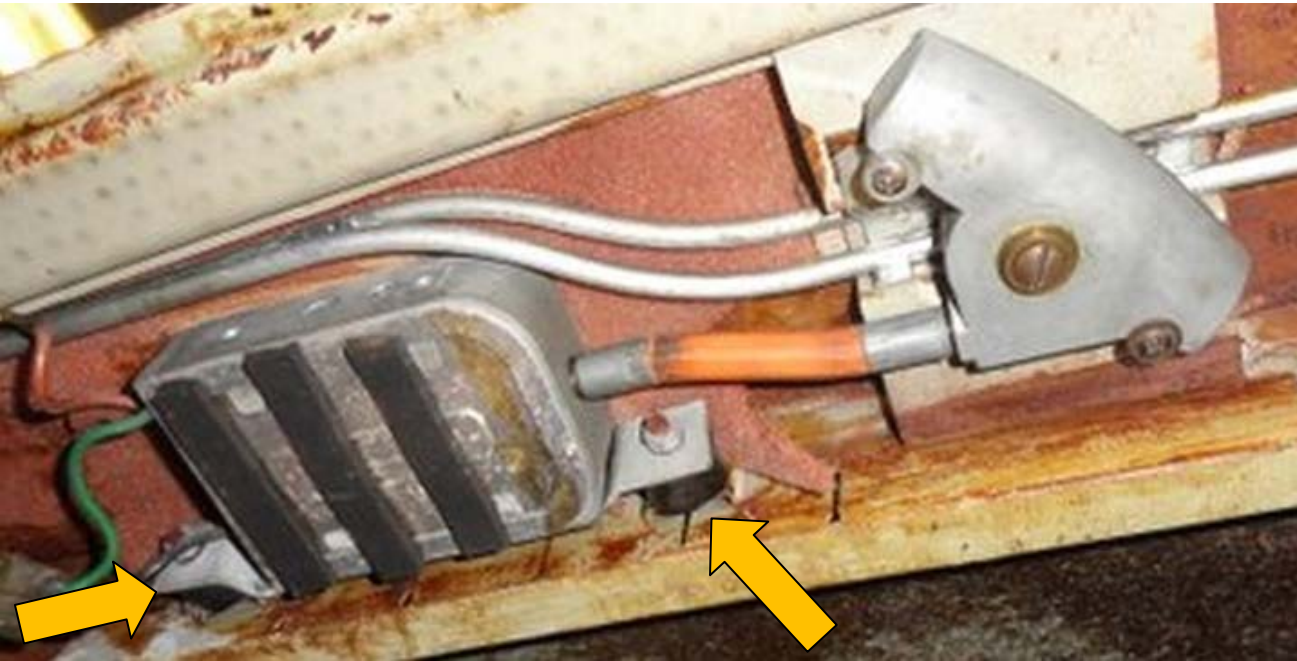

Resto Tip: Sunroof Motor Mounts

One of the unique parts of the electric sunroof models is the rubber buffers that eliminate vibrations from the electric sunroof motor. These round rubber buffers are, of course, unique to T34s and extremely difficult to find. When these buffers get old & crusty they tend to break apart & decompose (top right). When this happens the roof vibrates loudly when the sunroof is opened & closed and eventually the motor disconnects from the roof mounts.

I contacted a Porsche parts shop and was fortunate to find two sets of the Porsche equivalent of the sunroof motor mounts. They were called silentbloc (#901.624.511.05). With threads on either side & a black rubber buffer squeezed in-between, they were the closest possible replacement for the obsolete T34 parts.

A pair of 10mm nuts attach to the long side of the buffer which slides over the mounting bracket in the roof, tightens down, then the metal motor bracket can be added & another pair of 10mm nuts tightens the sunroof motor. It's a tight space working in the rear seat but nice when it's fixed.





Owner's Story: Wisconsin 1965 Project

Scott Brdlik lives in Two Rivers, Wisconsin USA and has been working hard on his March 1965 Coupe # 345132915.

He first came across the T34 design in early-2013 while he had been following Porsche ads on theSamba. He realized that Porsche prices have jumped in the last couple years to where it made no sense to buy one, so he began checking out the Type 3s & Beetles. The curious styling and rarity attracted him to the T34.

In May 2013 he bought his 1965 Coupe. It had been previously owned by Clifford Dildy who sold it in May 1991 to Michael Davis of Ellenwood Georgia. The body had been sanded-down to bare metal then left unprotected, so there was a thin coat of surface rust when he pulled it out from the storage garage (above).

He saw the original Cherry Red paint in the engine compartment & interior wheel well areas while the dash panel had been painted white. It was complete but in desperate need of a full restoration. Scott had plans to do the restoration work himself, not expecting a show car but rather something he could be proud of. He got in-touch with T34 World and began asking lots of questions about what was authentic for T34s.

Last year he traveled south to buy a front hood from Jim Schield and seats from Doug Narzczewski. The engine (below) was dirty but thankfully original & complete (with even the rare two-piece fuel pump) so he had it detailed. The turn signal lever had been broken & was hanging down, so that part went onto his search list.





The body was media-blasted in mid-2013 and the finishing work was done by the end of 2013 (above). Since there were already three restored T34s in his area that were Sea Blue Scott decided to return it to its original solid Cherry Red.





T34
WORLD

